

stryker

Aero[®]-C
**Anterior Cervical
Interbody and
Fixation System**

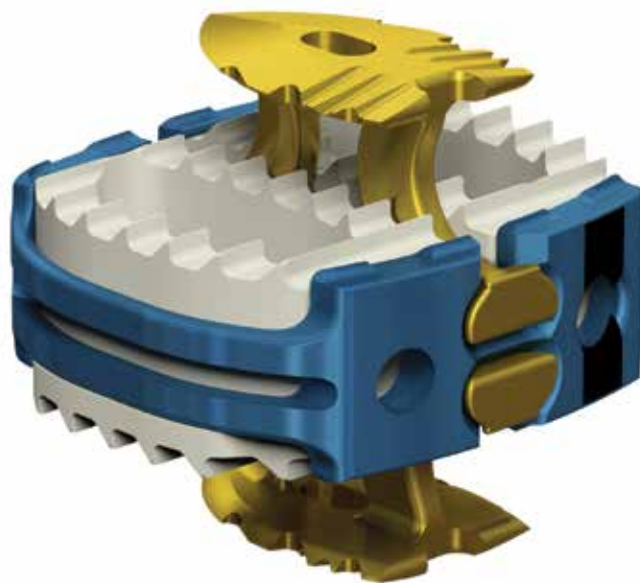

Surgical technique

Table of contents

System overview	3
Implant overview.	4
Surgical technique	
Step 1. Patient positioning and exposure	6
Step 2. Discectomy and endplate preparation	7
Step 3. Trialing	8
Step 4. Cage insertion.	10
Step 5. Superior anchor channel creation.	13
Step 6. Superior anchor insertion	14
Step 7. Inferior anchor insertion.	16
Step 8. Supplemental fixation	17
Implant removal	18
Implants	20
Instruments	21
Indications	23
Contraindications.	24

Acknowledgments:

Stryker wishes to thank the following surgeon for his dedication and contribution to the development of the Aero-C anterior cervical interbody and fixation system.

Hyun Bae, MD

System overview

The Aero-C anterior cervical interbody and fixation system is designed for use in anterior cervical interbody fusion procedures.

The system is comprised of:

- A PEEK Optima cage, surrounded by a titanium jacket. The PEEK cage is available in a variety of sizes to allow the surgeon to choose what is best suited to the patient's anatomy and pathology.
- Titanium anchors are guided through the cage, engaging with the posterior and anterior aspects of the device, and lock into the jacket to maximize segment stability and minimize micro-motion.
- The jacket spans the entire height of the cage anteriorly and posteriorly to show the overall height of the implant relative to the vertebral endplates as well as the cage-to-endplate proximity. The jacket and fixation anchors open on the lateral aspects to allow for fusion assessment through the lateral aspects on device radiographic images.
- Instrumentation designed to facilitate device insertion.

The Aero-C anterior cervical interbody and fixation system must be used with the anchor fixation provided.

This integrated system design offers the following benefits:

- **No anterior profile:** The instrumentation positions the cage in the interbody space so that there is no anterior protrusion of the device or locking mechanism. This reduces the risk of soft tissue irritation.
- **In-line approach:** The insertion of the anchors is in-line with the disc space, as opposed to the oblique angles typically used to insert screws. This reduces the potential of instrument impingement on the patient's anatomical structures like the chin and/or chest, and this allows the surgeon to minimize the exposure needed for device insertion.
- **Motion resistance:** The anchors secure the cage to the vertebral body, creating a construct capable of resisting physiologic motion in all degrees of freedom and to resist cage migration.
- **Compression creating anchors:** When inserted, the anchors are designed to draw the vertebral body towards the cage creating compressive forces at the endplate-to-cage interface.



Implant overview

The Aero-C cages are available in a wide variety of footprints, heights and lordotic angles to allow the surgeon to choose what is best suited to the patient's anatomy and pathology.

Aero-C cages						
Footprints (depth x width)	12mm x 14mm		14mm x 15mm		16mm x 17mm	
Lordosis	Parallel (0°)	Lordotic (6°)	Parallel (0°)	Lordotic (6°)	Parallel (0°)	Lordotic (6°)
Height	5mm	n/a	5mm	n/a	5mm	n/a
	6mm	6mm	6mm	6mm	6mm	6mm
	7mm	7mm	7mm	7mm	7mm	7mm
	8mm	8mm	8mm	8mm	8mm	8mm
	9mm	9mm	9mm	9mm	9mm	9mm
	10mm	10mm	10mm	10mm	10mm	10mm
Anchor color	Gray		Gold		Light green	
Anchor measurement (length x width)	8.5mm x 7.1mm		9.2mm x 6.6mm		11.2mm x 6.9mm	
Anchor height*	Parallel (0°) (5mm only) = 4.29mm, Parallel (0°) (6mm - 10mm) = 3.94mm, Lordotic (6°) (6mm - 10mm) = 3.86mm					

*Measurement from the superior/inferior aspect of jacket to the superior aspect of anchor

The PEEK cage and titanium jacket are pre-assembled. Two anchors provide fixation to the vertebral bodies and must be implanted during the procedure.

One sterile package includes: one cage assembly and two fixation anchors. The anchors are pre-loaded into plastic cartridges that are designed to facilitate anchor insertion and promote safe handling. Additional anchors are also packaged separately should an anchor lose sterility during surgery.



Anchor implant



Package

Surgical technique

The anchors are designed to engage both the anterior and posterior aspects of the jacket. The locking tab of the anchor engages the interior surface of the anterior face of the jacket to lock the anchor in place and prevent anterior migration (back-out) of the anchor. A stop feature engages the exterior surface of the anterior portion of the jacket to prevent posterior migration of the anchor.

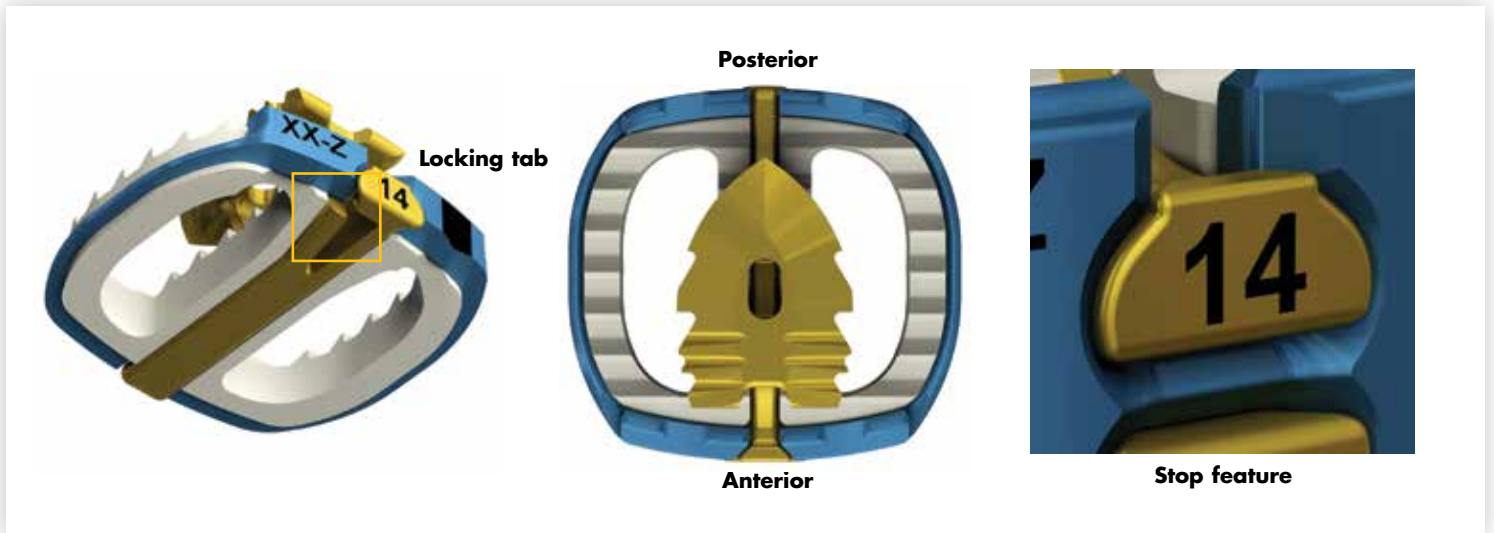

Surgical technique

Step 1. Patient positioning and exposure

Patient positioning should follow the surgeon's standard technique for any anterior cervical discectomy and fusion.

A direct anterior approach should be selected for the Aero-C implantation. The patient is placed in a supine position. Either a left side or right side approach can be used. A transverse or oblique incision parallel to the skin creases of the neck is recommended. After blunt dissection through the various layers, the anterior cervical spine is gently exposed. After exposing the vertebral bodies to be fused, prepare the fusion site following the appropriate technique for the given indication (Figure 1).

Care should be taken to remove any bony anatomy or osteophytes which might interfere with the instrumentation as this is required to position the Implant Inserter flush with the anterior aspect of the cervical spine.



Figure 1

Step 2. Discectomy and endplate preparation

Use preferred surgical approach and technique for the discectomy, using curettes, rongeurs, rasps or high speed drills.

The Aero-C cage is offered in a variety of sizes (Figure 2). It is recommended that the appropriate width be selected based on pre-operative measurements including an A/P fluoroscopic image.

Aero-C cages						
Footprints (depth x width)	12mm x 14mm		14mm x 15mm		16mm x 17mm	
Lordosis	Parallel (0°)	Lordotic (6°)	Parallel (0°)	Lordotic (6°)	Parallel (0°)	Lordotic (6°)
Height	5mm	n/a	5mm	n/a	5mm	n/a
	6mm	6mm	6mm	6mm	6mm	6mm
	7mm	7mm	7mm	7mm	7mm	7mm
	8mm	8mm	8mm	8mm	8mm	8mm
	9mm	9mm	9mm	9mm	9mm	9mm
	10mm	10mm	10mm	10mm	10mm	10mm

Aero-C anchors					
Cage footprint (depth x width)	Anchor size	Anchor color	Anchor dimensions (length x width)	Anterior recess (A)	Posterior recess (P)
12mm x 14mm	12mm	Gray	8.5mm x 7.1mm	2.0mm	1.5mm
14mm x 15mm	14mm	Gold	9.2mm x 6.6mm	2.0mm	2.8mm
16mm x 17mm	16mm	Light green	11.2mm x 6.9mm	2.0mm	2.8mm

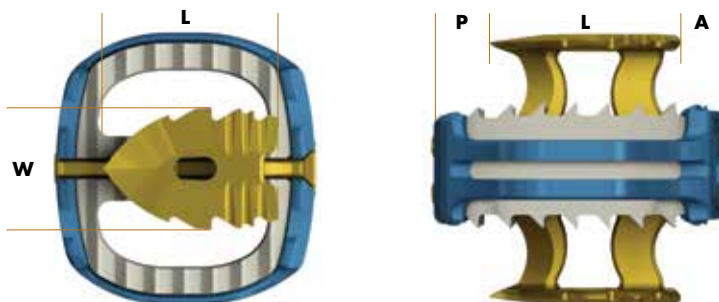

Figure 2

Use preferred technique for distraction. Distraction may be performed using the Parallel Pin Distractor from the Reliance-C instrumentation set, which is designed to facilitate both a left and right sided approach with a 360° rotation arm. Please note the corresponding anchor heights as listed in the chart above when determining distraction pin placement. Curettes can be used to elevate additional disc material from the endplates.

Prepare endplates so as to ensure good approximation with the superior and inferior surface of the interbody, as well as height of anchors superior and inferior to the interbody. Curettes or rasps should be translated parallel to the endplates until sufficient decortication is achieved. The curettes can be used to help determine that no soft tissue remains on the endplates.

Note: Distraction pins should be placed in the vertebral bodies adjacent to the prepared disc space so as to not interfere with the implant or instrumentation. It is recommended that distraction pins be placed in the most superior aspect of the superior vertebral body and the most inferior aspect of the inferior vertebral body.

Note: Both superior and inferior anchors will sit 3.86mm (lordotic), 3.94mm (parallel 6mm-10mm height), and 4.29mm (parallel 5mm height) above and below the interbody device.

Surgical technique

Step 3. Trialing

Final cage size can be determined using the appropriate color-coded trial. These trials have a color-coded marker that matches the cage height options. The trials are engraved to indicate footprint and lordosis (Figure 3).

Trials are available in three footprints:

Depth (mm)	Width (mm)
12	14
14	15
16	17

Additionally, trials are available in two degrees of angulation:

Parallel (0°)

Lordotic (6°)

The trials are engraved and color-coded by height to match the color-coding of the implants (Figure 3):

Aero-C trial sizes	
Color	Height
Blue	5mm, 6mm
Green	7mm
Magenta	8mm
Aqua	9mm
Purple	10mm



Figure 3

Note: It is recommended that the appropriate footprint trial be selected based on pre-operative measurements or fluoroscopy.

Note: Both the 5mm and 6mm trials are color-coded blue, corresponding to the blue Implant Inserter.

Note: Each trial measures 0.75mm shorter than the actual corresponding device height. This ensures that the implant teeth are fully engaged with the adjacent vertebral bodies. For example, a 7mm trial will measure 6.25mm, which is the height of the 7mm cage without the teeth (Figure 4). It is important to not oversize the trial as the overall cage height is 0.75mm taller than the trial when the height of the serrations is included.

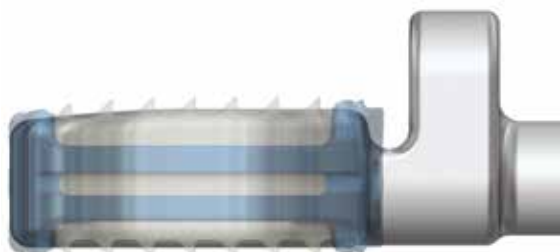

Figure 4

Surgical technique

Trials and Trial Inserter

Trials are available to assist in determining the appropriate cage size. These trials are designed to approximate the overall height, angulation and endplate dimensions of the disc space. Each trial option has a matching cage.

Insert the appropriate trial into the **Quick Release Handle** and carefully insert into the disc space. The trial should pass into the distracted disc space without excessive force. A **Mallet** can be used to aid insertion of the trial (Figure 5).



Quick Release Handle
48328050

Note: Trials are directional. Insert with the stop on the superior vertebral body.



Figure 5

The trials feature a built-in depth stop to control the amount the trial can be inserted (Figure 6). As needed, tap the Quick Release Handle with the Mallet to facilitate insertion of the trial.



Mallet
48890013

Note: Avoid applying cantilever or rotational forces during trialing step.



Figure 6

Consideration: Lateral radiographic imaging is recommended for confirming posterior trial-to-endplate contact. There should be no gaps between the endplates and the trial.

Surgical technique

Step 4. Cage insertion

Distraction pins may be removed prior to implant insertion so as not to interfere with the instrumentation.

Once the final cage size has been determined using the trials, select the corresponding Aero-C cage and **Implant Inserter**. The jackets on the cages and the Implant Inserters are also color-coded by implant height, similar to the trials (Figure 7).



**Implant Inserter
48890006**





Aero-C Implant Inserter			
	Reference number	Color	Height
	48890006	Blue	5mm, 6mm
	48890007	Green	7mm
	48890008	Magenta	8mm
	48890009	Aqua	9mm
	48890010	Purple	10mm

Figure 7

Loading the implant directly from the sterile package, attach the cage to the appropriate Implant Inserter for the implant height selected (Figure 8).



Figure 8

Note: The Implant Inserters are used to implant both the cage and the anchors.

Note: Both the 5mm and 6mm height implants are inserted using the blue-handled Implant Inserter. Correspondingly, the 5mm and 6mm trials and implants are all color-coded blue.

Surgical technique

The cage should be inserted according to the correct superior and inferior orientation. The jacket of each cage is marked with the text “SUP” to indicate the superior end (Figure 9).



Figure 9

Thread the Implant Inserter by rotating the thumb screw clockwise until snug.

With the cage attached to the Implant Inserter, pack both graft chambers with bone graft. Ensure bone anchor channels are clear of debris and bone graft.

Tip: To ensure proper orientation of the cage, match the line on the Implant Inserter with the line on the cage jacket (Figure 10).



Figure 10

Graft volume							
Footprint	12mm x 14mm		14mm x 15mm		16mm x 17mm		
Lordosis	Parallel (0°)	Lordotic (6°)	Parallel (0°)	Lordotic (6°)	Parallel (0°)	Lordotic (6°)	
Graft area (mm ²)	39.5	39.5	61	61	82.2	82.2	
Graft volume (mm ³)	5mm	207	n/a	320	n/a	432	n/a
	6mm	235	239	364	370	490	496
	7mm	274	278	423	429	570	576
	8mm	313	317	483	489	651	657
	9mm	352	356	544	550	733	739
	10mm	391	395	605	611	815	821

Surgical technique

Position the superior side of cage (marked "SUP") on the Implant Inserter on the midline towards the superior vertebral body. Place the cage into the disc space, and gently tap the end of the Implant Inserter using the Mallet. The implant is fully implanted when the depth stop on the Implant Inserter makes contact with the anterior aspect of both the superior and inferior vertebral bodies (Figure 11). The Implant Inserter is designed to locate the device approximately flush with the anterior aspect of the vertebral bodies.



Figure 11

Note: When properly attached, the anterior face of the cage should be in direct contact with the Implant Inserter and firmly secured. No gap should be present between cage and the Implant Inserter.

Note: Avoid applying cantilever or rotational forces during implant insertion step.

Note: Ensure that there is no bone graft material left in the channels of the implant.

Note: Ensure a tight fit between the implant and the endplates such that there is no gap at the superior or inferior face of the device. If a gap were to occur it could affect the insertion/performance of the anchors.

Note: It is recommended that implant positioning be confirmed using fluoroscopy prior to inserting the anchors.

Step 5. Create superior anchor channel

The **Pilot Cutter** must be used to create a channel for the anchors.

Starting with the superior aspect of the implant, attach the Pilot Cutter onto the Implant Inserter by mating it with the guiding flanges on the superior side of Implant Inserter (Figure 12). Slide the Pilot Cutter down until it rests against the superior vertebral body.



Figure 12

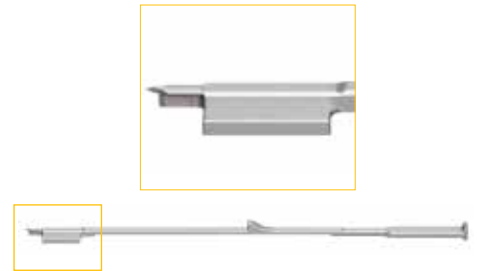

**Pilot Cutter
48890002**

Note: Ensure the disc space is not distracted when using the Pilot Cutter or implanting the anchors.

Using the Mallet, tap the Pilot Cutter gently to penetrate the bone and create a channel. A built-in depth stop limits the depth of the Pilot Cutter insertion (Figure 13).

Remove the Pilot Cutter from the vertebral body by engaging the Mallet prongs with the Pilot Cutter central ridge and gently tapping the Pilot Cutter back out of the vertebral body.



Figure 13

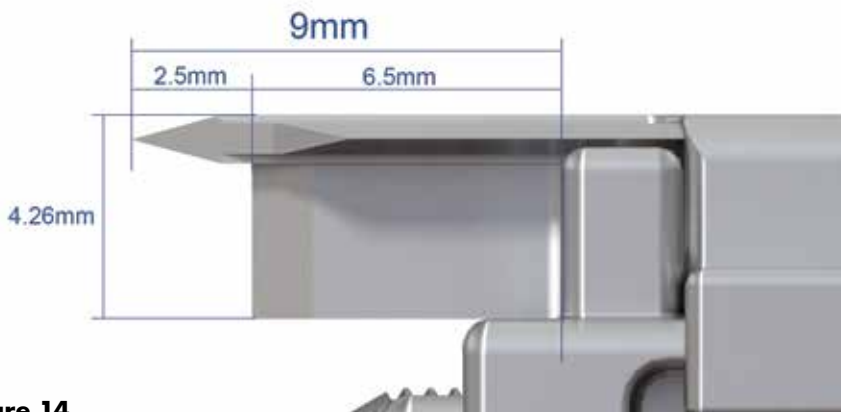

Figure 14

Note: 9mm is measured from the distal tip of the Pilot Cutter bevel to the built-in depth stop on the Implant Inserter. The bevel measures 2.5mm and the remaining cutting blade measures 6.5mm. The vertical height of the Pilot Cutter measured from the superior aspect of the bevel to the inferior aspect of the cutting blade measures 4.26mm (Figure 14).

Step 6. Superior anchor insertion

The superior anchor must be inserted before the inferior anchor.

The anchors are packaged in a plastic cartridge to protect the handler from the sharp edges. These cartridges are designed to facilitate anchor insertion and promote safe handling. The anchors are packaged with a cage corresponding to the footprint of that cage (Figure 15).



Figure 15

If a replacement anchor is required, select the appropriate size:

Aero-C anchors					
Cage footprint (depth x width)	Anchor size	Anchor color	Anchor dimensions (length x width)	Anterior recess (A)	Posterior recess (P)
12mm x 14mm	12mm	Gray	8.5mm x 7.1mm	2.0mm	1.5mm
14mm x 15mm	14mm	Gold	9.2mm x 6.6mm	2.0mm	2.8mm
16mm x 17mm	16mm	Light green	11.2mm x 6.9mm	2.0mm	2.8mm

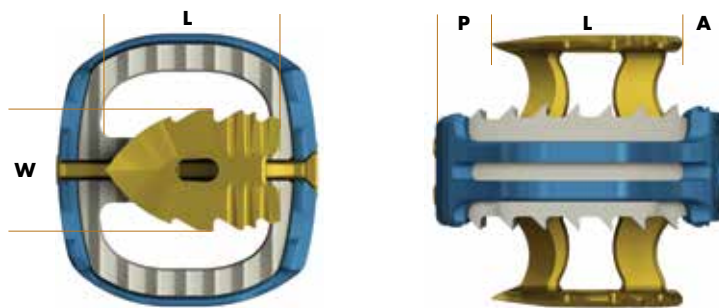

Remove the anchor/cartridge assembly from the sterile package by grasping the cartridge tab.

Starting with the superior anchor, slide the cartridge down the Implant Inserter channel by mating it with the guiding flanges on the superior side of Implant Inserter (Figure 16). The anchor should face toward the vertebral body. Grasp the anchor cartridge and press downward to release the anchor. The anchor will then slide down the channel to partially engage the implant. The cartridge can then be discarded. Anchors should penetrate the anterior face of the vertebral body when impacted with the **Anchor Tamp**.



**Anchor Tamp
48890001**

Note: Anchor Tamp has a rectangular laser mark to distinguish it from the Pilot Cutter.

Note: Attach an Anchor Tamp to the superior side of the Implant Inserter using the guiding flanges, and then slide the Anchor Tamp down the Implant Inserter until it contacts the anchor (Figure 17).



Figure 16

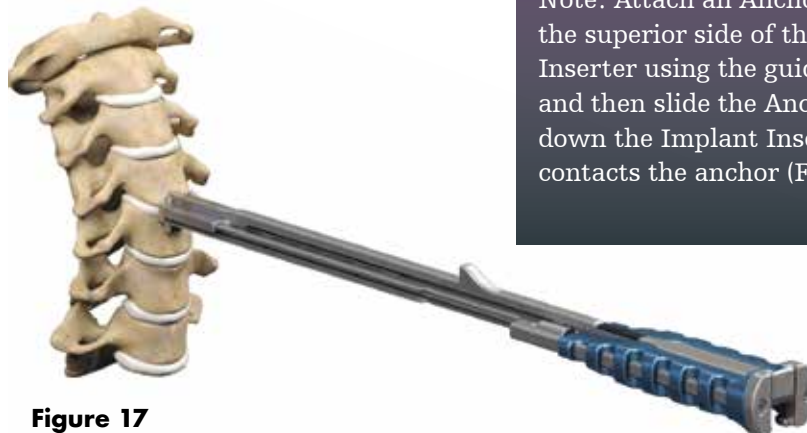

Figure 17

Surgical technique

Use the Mallet to tap the Anchor Tamp until it is fully seated with the end of the Implant Inserter (Figure 18). Built-in depth stops will automatically control the depth of anchor insertion.



Figure 18



The anchors penetrate the anterior face of the vertebral body during insertion.

The anchor is locked in the cage when the Anchor Tamp is fully seated with the proximal end of the Implant Inserter handle. The depth stop on the Anchor Tamp will contact the Implant Inserter when the anchor is fully inserted providing both tactile and audible feedback (Figure 19).



Figure 19

Surgical technique

Step 7. Inferior anchor channel and insertion

Leave the superior Anchor Tamp in place, and repeat steps 5 and 6 for the inferior anchors.

When both anchors are locked in the cage, remove the Anchor Tamps. The Mallet prongs may be used to facilitate the removal of the Anchor Tamp.

Release the implants from the Implant Inserter by unthreading the thumb screw by rotating counterclockwise. Visually confirm and use lateral fluoroscopic images to verify that the anchors are flush with the jacket.

If the anchor is not locked to the jacket, the anchor will protrude approximately 1.25mm anteriorly. If after removing the Implant Inserter and Anchor Tamp, the anchor still appears proud, use the **Tamp** for final placement.

Place distal end of Tamp against the superior dovetail and tap with Mallet to ensure the anchor is fully seated (Figure 20).

Note: Use caution to not apply cantilever loading during anchor insertion.



Tamp
48890003

Note: Be sure the Tamp is perpendicularly aligned with the dovetail. Use caution to not apply off-axis loading when using the tamp.



Figure 20

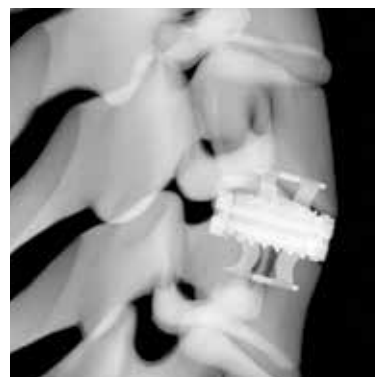

Aero-C fully implanted

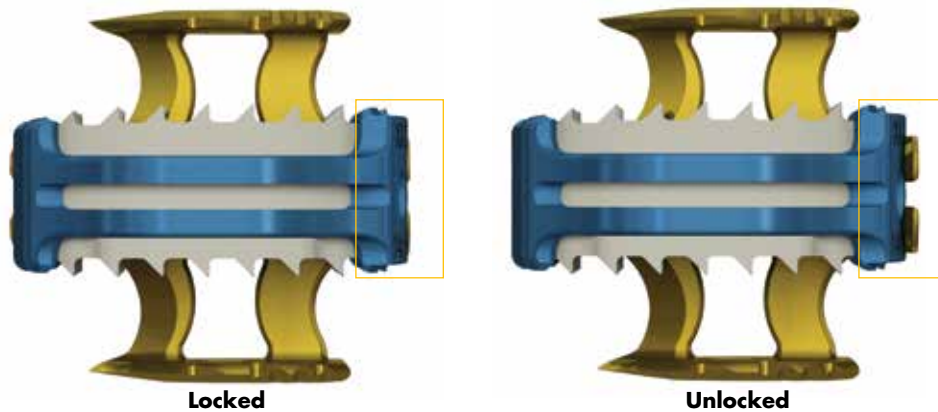

Note: Once the anchors are locked, they cannot be removed from the cage (Figure 21). If removal is required, the entire cage/anchor assembly must be removed.

Figure 21

Step 8. Supplemental fixation

With all of the anchors inserted and locked in place, supplemental fixation that has been cleared by the FDA for use in the cervical spine must be used to augment stability of the Aero-C construct.

Note: Take care to place the supplemental fixation so that it does not interfere with the anchors.

Implant removal

A surgical revision may be indicated for many reasons including new or unresolved pain or neurological symptoms, changes in device positioning, etc. The surgeon must use his/her professional judgment to determine the appropriate revision strategy taking into consideration the patient's health, the nature of the problem and/or device failure, the patient's bone quality, and the surgeon's expertise with other spinal treatments and instrumentation.

Should the implant need to be removed for any reason, utilize the **Revision Guide** and **Revision Housing** instruments to remove the cage/anchor assembly (Figure 22). The revision instruments are designed with a threaded persuader mechanism to allow removal of the implant without impaction.



Figure 22

Align the Revision Guide with the implant by matching the laser marked line of the instrument with the line on the implant. Tighten the thumbscrew until it is flush with the shoulder of the Revision Guide.

Align the Revision Housing with the Revision Guide and slide over the Revision Guide so that the text "SUP" is on the superior vertebral body.



Revision Guide
48890014



Revision Housing
48890015

Surgical technique

Once the Revision Housing is fully seated, turn the T-Handle clockwise until the implant is extracted (Figure 23).



Figure 23

Release the Revision Guide from the housing assembly by rotating the finger grooves on T-Handle. Release the implant from the Revision Guide by rotating the thumb screw counterclockwise.

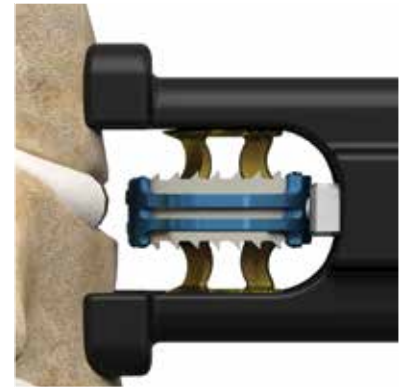

Removed Implant

Note: Once an Aero-C implant has been inserted and removed, another Aero-C implant cannot be placed at that level. Alternative anterior cervical instrumentation should be used.

Note: Following implant removal, disassemble the Revision Housing and Revision Guide for cleaning and sterilization.

Implants



Aero-C cage and anchor package*

Footprint height	12mm x 14mm		14mm x 15mm		16mm x 17mm	
	Parallel (0°)	Lordotic (6°)	Parallel (0°)	Lordotic (6°)	Parallel (0°)	Lordotic (6°)
5mm	48892050	n/a	48894050	n/a	48896050	n/a
6mm	48892060	48892066	48894060	48894066	48896060	48896066
7mm	48892070	48892076	48894070	48894076	48896070	48896076
8mm	48892080	48892086	48894080	48894086	48896080	48896086
9mm	48892090	48892096	48894090	48894096	48896090	48896096
10mm	48892100	48892106	48894100	48894106	48896100	48896106













* Each reference includes one cage and two anchors







Aero-C single anchors

Size (mm)	Reference number
12	48892000
14	48894000
16	48896000

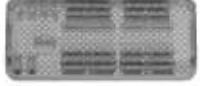
Instruments

Aero-C general instruments		
	Reference number	Description
	48890001	Anchor Tamp
	48890002	Pilot Cutter
	48890003	Tamp
	48328050	Quick Release Handle
	48890013	Mallet
	48890006	Implant Inserter, 5 and 6mm
	48890007	Implant Inserter, 7mm
	48890008	Implant Inserter, 8mm
	48890009	Implant Inserter, 9mm
	48890010	Implant Inserter, 10mm
	48890014	Revision Guide
	48890015	Revision Housing

Aero-C general instruments		
	Reference number	Description
	48890000	Instrument Container
	48890000A	Instrument Tray Top
	48890000B	Instrument Tray Middle
	48890000C	Instrument Tray Base
	48890000D	Instrument Tray Lid

Aero-C trials						
Footprint height	12mm x 14mm		14mm x 15mm		16mm x 17mm	
	Parallel (0°)	Lordotic (6°)	Parallel (0°)	Lordotic (6°)	Parallel (0°)	Lordotic (6°)
5mm	48890205	n/a	48890405	n/a	48890605	n/a
6mm	48890206	48896206	48890406	48896406	48890606	48896606
7mm	48890207	48896207	48890407	48896407	48890607	48896607
8mm	48890208	48896208	48890408	48896408	48890608	48896608
9mm	48890209	48896209	48890409	48896409	48890609	48896609
10mm	48890210	48896210	48890410	48896410	48890610	48896610

Important product information for Aero-C

Sterile product

Description

The Aero-C cage is a hollow, ring-shaped PEEK Optima cage surrounded by a titanium alloy (Ti-6Al-4V) jacket. The PEEK Optima cage portion consists of two closed pockets for graft containment and has serrations on the superior and inferior surfaces of the cage. The implant is designed to be used with the internal supplemental fixation provided (Aero-C fixation anchors) in addition to supplemental fixation systems cleared for use in the cervical spine. The Aero C fixation anchors are constructed from titanium alloy (Ti-6Al-4V) and feature rails that mate with dovetail channels located within the Aero-C PEEK cage. Once fully seated into the channels, the anchors are designed to lock into the titanium jacket.

Material

All components of the system are manufactured out of the following materials:

- Cage: Polyetheretherketone (PEEK Optima LT1) (ASTM F2026) and Titanium Alloy Ti6Al4V (ISO 5832-3, ASTM F136)
- Fixation anchors: Titanium Alloy Ti6Al4V (ISO 5832-3, ASTM F136)

Indications

The Stryker Aero-C cervical cage is indicated for use in cervical interbody fusion procedures in skeletally mature patients with degenerative disc disease (DDD) at one level from the C2-C3 disc to the C7-T1 disc.

DDD is defined as neck pain of discogenic origin with degeneration of the disc confirmed by history and radiographic studies. These patients should be skeletally mature and have six weeks of non-operative therapy.

The Aero-C cervical cage system is to be used with autogenous bone graft and/or allogenic bone graft comprised of cancellous and/or corticocancellous bone graft, and is to be implanted via an open, anterior approach.

The Aero-C cervical cage system is intended to be used with supplemental spinal fixation systems that have been cleared for use in the cervical spine. In addition, the device must be used with the included fixation anchors.

General conditions of use

The implantation of intervertebral body fusion devices must be performed only by experienced spinal surgeons having undergone the necessary specific training in the use of such systems because this is a technically demanding procedure presenting a risk of serious injury to the patient.

The information contained in the Package Insert is necessary but not sufficient for the use of this device. This information is in no sense intended as a substitute for the professional judgment, skill and experience of the surgeon in careful patient selection, preoperative planning and device selection, knowledge of the anatomy and biomechanics of the spine, understanding of the materials and the mechanical characteristics of the implants used, training and skill in spinal surgery and the use of associated instruments for implantation, securing the patient's cooperation in following an appropriately defined post-operative management program and conducting scheduled post-operative follow-up examinations.

Caution

- Federal law (U.S.A.) restricts this device to sale by or on the order of a licensed physician.
- This device is not intended for posterior surgical implantation.
- This device is NOT intended to be used without the Aero-C fixation anchors provided. Should removal of the Aero-C fixation anchors be necessary during the surgery, the Aero-C cage should NOT be implanted alone, without the support of the Aero-C fixation anchors.
- Once an Aero-C implant has been inserted and removed, another Aero-C implant cannot be placed at that level.

If revision surgery is required at that level, Stryker's anterior cervical plate and PEEK interbody spacers or AVS Anchor-C cervical cage system are recommended.

- This device is provided STERILE. Do not use if package is opened or damaged or after the "Use by" date on the label has expired.
- The Aero-C cervical cages have not been evaluated for safety and compatibility in the MR environment. Aero-C cervical cages have not been tested for heating or migration in the MR environment.
- Based on the fatigue testing results, the physician/surgeon must consider the levels of implantation, patient weight, patient activity level, other patient conditions, etc. which may impact the performance of the intervertebral body fusion device.
- The implantation of the intervertebral body fusion device must be performed only by experienced spinal surgeons with specific training in the use of this device because this is a technically demanding procedure presenting a risk of serious injury to the patient.
- Potential risks identified with the use of this intervertebral body fusion device, which may require additional surgery, include: device component fracture, loss of fixation, pseudoarthrosis (i.e. non-union), fracture of the vertebrae, neurological injury, and vascular or visceral injury.
- Patients with previous spinal surgery at the level to be treated may have different clinical outcomes compared to those without a previous surgery.
- The components of the system should not be used with components of any other system or manufacturer. Any such use will negate the responsibility of Stryker for the performance of the resulting mixed component implant.
- Do not mix metals (e.g. titanium based devices with stainless steel items). Some corrosion occurs on all implanted metals and alloys. Contact of dissimilar metals, however, may accelerate corrosion. Corrosion may accelerate fatigue fracture of implants, and cause metal compounds to be released into the body.

Contraindications

Contraindications may be relative or absolute. The choice of a particular device must be carefully weighed against the patient's overall evaluation. Circumstances listed below may reduce the chances of a successful outcome:

- The Aero-C cervical cage should not be implanted in patients with an active infection at the operative site.
- The Aero-C cervical cage is not intended for use except as indicated.
- Marked local inflammation.
- Any abnormality present which affects the normal process of bone remodeling including, but not limited to, severe osteoporosis involving the spine, bone absorption, osteopenia, primary or metastatic tumors involving the spine, active infection at the site or certain metabolic disorders affecting osteogenesis.
- Any mental or neuromuscular disorder which would create an unacceptable risk of fixation failure or complications in postoperative care.
- Open wounds.
- Pregnancy.
- Inadequate tissue coverage over the operative site.
- Any neuromuscular deficit which places an unsafe load level on the device during the healing period.
- Obesity. An overweight or obese patient can produce loads on the spinal system which can lead to failure of the fixation of the device or to failure of the device itself.
- A condition of senility, mental illness, or substance abuse. These conditions, among others, may cause the patient to ignore certain necessary limitations and precautions in the use of the implant, leading to failure or other complications.
- Foreign body sensitivity. Where material sensitivity is suspected, appropriate tests must be made prior to material selection or implantation.
- Other medical or surgical condition which would preclude the potential benefit of spinal implant surgery, such as the presence of tumors, congenital abnormalities, elevation of sedimentation rate unexplained by other diseases, elevation of white blood cell count (WBC), or marked left shift in the WBC differential count.
- Prior fusion at the level to be treated.

These contraindications may be relative or absolute and must be taken into account by the physician when making his decision. The above list is not exhaustive. Surgeons must discuss the relative contraindications with the patients.

Pre-operative precautions

The surgical indication and the choice of implants must take into account certain important criteria such as:

- Patients involved in an occupation or activity that applies excessive loading upon the implant (e.g., substantial walking, running, lifting, or muscle strain) may be at increased risk for failure of the fusion and/or the device.
- Surgeons must instruct patients in detail about the limitations of the implants, including, but not limited to, the impact of excessive loading through patient weight or activity, and be taught to govern their activities accordingly. The procedure will not restore function to the level expected with a normal, healthy spine, and the patient should not have unrealistic functional expectations.
- A condition of senility, mental illness, chemical dependence or alcoholism. These conditions among others may cause the patients to ignore certain necessary limitations and precautions in the use of the implant, leading to failure and other complications.
- Foreign body sensitivity. Where material sensitivity is suspected appropriate tests should be made prior to material implantation.
- Surgeons must advise patients who smoke have been shown to have an increased incidence of non-unions. Such patients must be advised of this fact and warned of the potential consequences.
- Care must be taken to protect the components from being marred, nicked, or notched as a result of contact with metal or abrasive objects.

Intra-operative precautions

- The insertion of the implants must be carried out using instruments designed and provided for this purpose and in accordance with the specific implantation instructions for each implant. Those detailed instructions are provided in the surgical technique brochure supplied by Stryker.
- Discard all damaged or mishandled implants.
- Never reuse an implant, even though it may appear undamaged.

Adverse effects

Include but are not limited to:

- Late bone fusion or no visible fusion mass and pseudarthrosis;
- While the expected life of spinal implant components is difficult to estimate, it is finite. These components are made of foreign materials which are placed within the body for the potential fusion of the spine and reduction of pain. However, due to the many biological, mechanical and physicochemical factors which affect these devices but cannot be evaluated in vivo, the components cannot be expected to indefinitely withstand the activity level and loads of normal healthy bone;
- Superficial or deep-set infection and inflammatory phenomena;
- Allergic reactions to the implanted materials, although uncommon, can occur;
- Decrease in bone density due to stress shielding;
- Dural leak requiring surgical repair;
- Peripheral neuropathies, nerve damage, heterotopic bone formation and neurovascular compromise, including paralysis, loss of bowel or bladder function, or foot-drop may occur.
- Cessation of growth of the fused portion of the spine;
- Loss of proper spinal curvature, correction, height and/or reduction;
- Delayed Union or Nonunion: Internal fixation appliances are load sharing devices which are used to obtain alignment until normal healing occurs. In the event that healing is delayed, does not occur, or failure to immobilize the delayed/nonunion results, the implant will be subject to excessive and repeated stresses which can eventually cause loosening, bending or fatigue fracture. The degree or success of union, loads produced by weight bearing, and activity levels will, among other conditions, dictate the longevity of the implant. If a nonunion develops or if the implants loosen, bend or break, the device(s) must be revised or removed immediately before serious injury occurs;
- Neurological and spinal dura mater lesions from surgical trauma;

Surgical technique

- Early loosening may result from inadequate initial fixation, latent infection, premature loading of the device or trauma. Late loosening may result from trauma, infection, biological complications or mechanical problems, with the subsequent possibility of bone erosion, or pain.
- Serious complications may occur with any spinal surgery. These complications include, but are not limited to, genitourinary disorders; gastrointestinal disorders; vascular disorders, including thrombus; bronchopulmonary disorders, including emboli; bursitis, hemorrhage, myocardial infarction, infection, paralysis or death.
- Inappropriate or improper surgical placement of this device may cause distraction or stress shielding of the graft or fusion mass. This may contribute to failure of an adequate fusion mass to form.
- Intraoperative fissure, fracture, or perforation of the spine can occur due to implantation of the components. Postoperative fracture of bone graft or the intervertebral body above or below the level of surgery can occur due to trauma, the presence of defects, or poor bone stock.

Adverse effects may necessitate reoperation or revision. The surgeon must warn the patient of these adverse effects as deemed necessary.

Removal

If fusion / bone graft growth occurs, the device will be deeply integrated into the bony tissues. As a result, the Aero-C is not intended to be removed unless the management of a complication or adverse event requires the removal.

Any decision by a physician to remove the device should take into consideration such factors as:

- The risk to the patient of the additional surgical procedure as well as the difficulty of removal.
- Migration of the implant, with subsequent pain and/or neurological, articular or soft tissue lesions
- Pain or abnormal sensations due to the presence of the implants
- Infection or inflammatory reactions
- Reduction in bone density due to the different distribution of mechanical and physiological stresses and strains.



A surgeon must always rely on his or her own professional clinical judgment when deciding whether to use a particular product when treating a particular patient. Stryker does not dispense medical advice and recommends that surgeons be trained in the use of any particular product before using it in surgery.

The information presented is intended to demonstrate the breadth of Stryker product offerings. A surgeon must always refer to the package insert, product label and/or instructions for use before using any Stryker product. Products may not be available in all markets because product availability is subject to the regulatory and/or medical practices in individual markets. Please contact your Stryker representative if you have questions about the availability of Stryker products in your area.

Stryker Corporation or its divisions or other corporate affiliated entities own, use or have applied for the following trademarks or service marks: Aero, Stryker. All other trademarks are trademarks of their respective owners or holders.

CVAER-ST-1_Rev-1
SC/GS 04/16

Copyright © 2016 Stryker
Printed in USA



Stryker's Spine Division
2 Pearl Court
Allendale, NJ 07401-1677 USA
t: 201 749 8000
www.stryker.com